



**2 velocità (2.400-3.000rpm)  
 Peso gr.430  
 cavo lungo mt.3  
 motore 45W  
 Inc. Testina mm.1,8**

>>  
TOSKM2



>>  
SR400



Articolo	Descrizione	qmv	crt
TOSKM2	Tosatrice Wahl KM2 a 2 vel. c/test. mm.1,8	1	1
SR400	Spray Raffreddante Blade Ice ml.400	1	12



**2 velocità (3.000-3.500rpm)  
Peso gr.360  
cavo lungo mt.4,2  
Inc. Testina mm.1,8**

>>  
TOSKM5

**Brushless  
Power**

**2 velocità (3.000-3.700rpm)  
Peso gr.350  
cavo lungo mt.4,2  
motore brushless 24W  
Inc. Testina mm.1,8**



<<  
TOSKM10



Articolo	Descrizione	qmv
TOSKM5	Tosatrice Wahl KM5 -2 Vel. c/test. mm.1,8	1
TOSKM10	Tosatrice Wahl KM10 -2 Vel. c/test. mm.1,8	1

>>  
TOSREX



**15W**  
**Peso gr.620**  
**60db**  
**cavo lungo mt.3**  
**lama 0,7-3mm**



>>  
TOS1400

**10W**  
**Peso gr.520**  
**cavo lungo mt.2**  
**lama 0,7-3mm**



Articolo	Descrizione	qmv
TOSREX	Tosatrice Moser REX 1230 x 15W c/lama	1
TOS1400	Tosatrice Moser 1400 da 10W c/lama	1



**Batteria ioni Litio**  
**Autonomia 120 minuti**  
**Ricarica completa 75min**  
**Peso gr.280**  
**velocità 5.300 rpm**  
**cordless c/2 batterie**  
**testina Magic Blade inclusa**  
**larghezza di taglio 46 mm**  
**lunghezza di taglio da 0,7 a 3mm**



<<  
TOSARCO



<<  
TOSBRAR

>>  
TOSAAW



Articolo	Descrizione	qmv
TOSARCO	Tosatrice cordless Moser <b>Arco Pro</b> + 2 AKKU	1
TOSBRAR	Testina Ricambio Bravura/Arco mm.0,7-3	1
TOSAAW	Anello Antiscivolo Wahl	1



<<  
TOSHO

**Batteria al Litio 2.850mAh  
autonomia 240 minuti  
Ricarica Veloce 60min  
peso(incluso batt.) gr.415  
2 velocità 2.600/3.100 rpm  
rumorosità 59db**



**SWISS  
MADE**



>>  
TOSHS

**Batteria al Litio 1.600mAh  
autonomia 120 minuti  
Ricarica Veloce 60min  
peso(incluso batt.) gr.425  
motore da 35W  
velocità 2.650 rpm  
rumorosità 69db**



Articolo	Descrizione	qmv
TOSHO	Tosatrice Heiniger Opal cordless +2 akku +test.#10 mm.1,5	1
TOSHS	Tosatrice Heiniger Saphir cordless +2 akku +test.#10 mm.1,5	1



>>  
TOSGT104

**caratteristiche:**  
**motore 35W**  
**2.300 rpm**  
**70db**  
**peso gr.650**  
**lunghezza cavo 5mt**

**Pettini Aesculap**



>>  
TOSGT105



**caratteristiche:**  
**motore 35W**  
**2.300 rpm**  
**70db**  
**peso gr.650**  
**lunghezza cavo 5mt**



**FREE**



<<  
PAE75341



<<  
PAE75342

Articolo	Descrizione	qmv
TOSGT104	Tosatrice Aesculap Favorita II GT104 s/testina	1
TOSGT105	“ “ Fav5 GT105 c/test.1,5mm	1
PAE1.2	Pettine Aesculap GT 730 mm. 1/2	1
PAE1	“ “ GH 712 mm. 1 -- 27denti	1
PAE2.742	“ “ GT 742 mm. 2 -- 19denti	1
PAE3	“ “ GT 754 mm. 3 -- 19denti	1
PAE3.748	“ “ GT 748 mm. 3 -- 14denti	1
PAE5	“ “ GT 758 mm. 5	1
PAE7	“ “ GT 770 mm. 7 -- 14denti	1
PAE9	“ “ GT 779 mm. 9	1
PAE12	“ “ GT 782 mm. 12	1
PAE16	“ “ GT 784 mm. 16	1
PAE75341	C/ Pettine Aesculap GT 501 - 15 Denti	1
PAE75342	“ “ GT 502 - 31 Denti mm.3	1

## Pettini MOSER

<<

PTM1225A	mm.1/20	#50F
PTM1225B	mm.1/10	#40F
PTM1225C	mm.1	#30F
PTM1225D	mm.2	#10F
PTM1225E	mm.3	#8,5F
PTM1225G	mm.5	#7F
PTM1225H	mm.7	#5F
PTM1225I	mm.9	#4F



>>  
RSET mm.3/6/10/13/16/19/22/25

**rialzi originali MOSER utilizzabili  
con le testine Size #8,5 #9 #10 #15 #30  
non monta su #40 #50**



<<  
TOSHR  
mm.3/6/10/13/16/19/22/25/32

**rialzi originali HEINIGER utilizzabili  
solo con le testine Size 50-40-30-15-10**



>>  
RO08 #2 mm. 8 1/4"  
RO14 #4 mm.14 1/2"  
RO18 #6 mm.18 3/4"  
RO25 #8 mm.25 1"





PPH0,25 #40 mm.0,25



PPH1,6 #10 mm.1,6



PPH2 #9 mm.2



PPH3 #7F mm.3



PPH9 #4F mm.9



PPH13 #3F mm.13



PPHC18 c/pett.18denti



PPHT3 #7F mm.3



PPHT6 #5F mm.6



<< FTM10

**cm.10,5  
gr.18**

**cm.15  
gr.44**

>> FT15



<< FT18

**cm.18  
gr.60**

**cm.18  
gr.76**

>> FT18C



<< FT20

**cm.19,5  
gr.82**

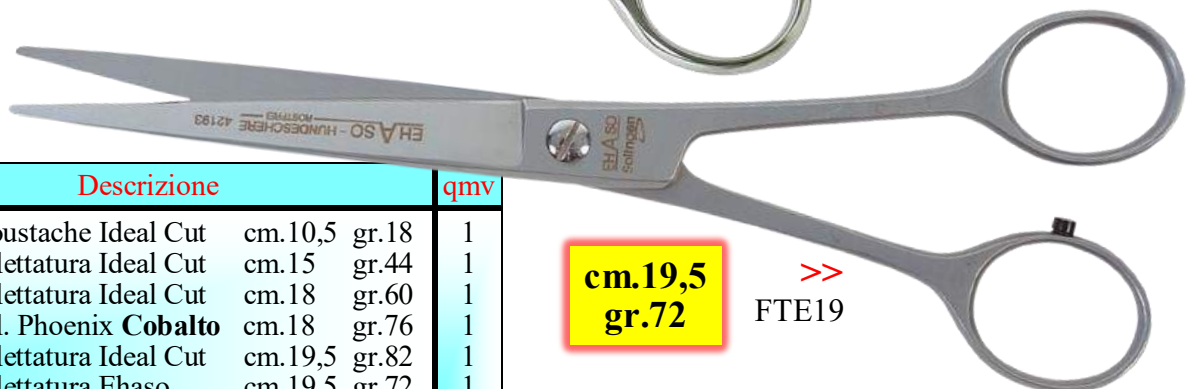

**cm.19,5  
gr.72**

>> FTE19

Articolo	Descrizione	cm.	gr.	qmv
FTM10	Forbici Moustache Ideal Cut	cm.10,5	gr.18	1
FT15	Forbici Toilettatura Ideal Cut	cm.15	gr.44	1
FT18	Forbici Toilettatura Ideal Cut	cm.18	gr.60	1
FT18C	Forbici Tol. Phoenix <b>Cobalto</b>	cm.18	gr.76	1
FT20	Forbici Toilettatura Ideal Cut	cm.19,5	gr.82	1
FTE19	Forbici Toilettatura Ehaso	cm.19,5	gr.72	1

**cm.16  
gr.56**

>>  
FTD16



<<  
FTDD

**cm.15,5  
gr.56**

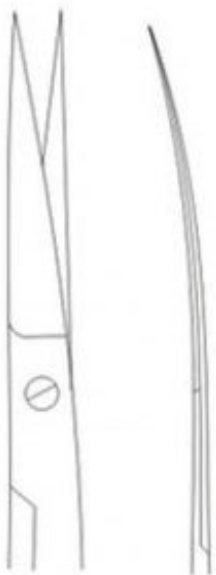

**cm.18  
gr.62**

>>  
FTC18



<<  
FTC20

**cm.20  
gr.88**

**cm.19  
gr.72**

>>  
FTEC19

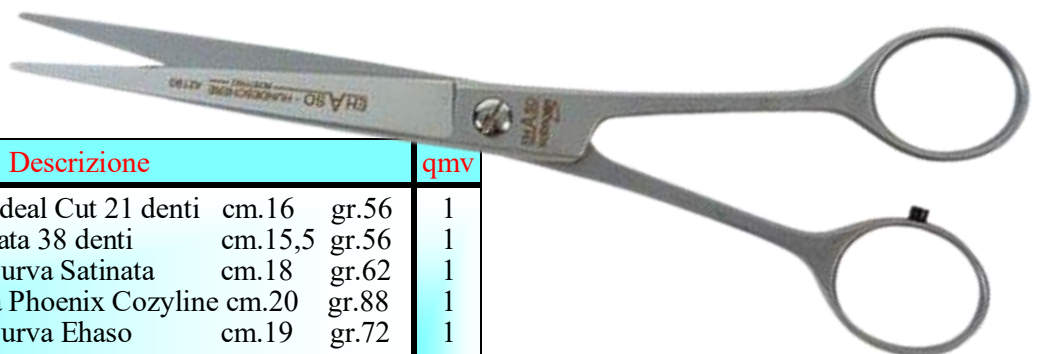

Articolo	Descrizione	cm	gr	qmv
FTD16	Forbici 1/2 Dentata Ideal Cut 21 denti	cm.16	gr.56	1
FTDD	Forbici Doppia Dentata 38 denti	cm.15,5	gr.56	1
FTC18	Forbici Toilettatura Curva Satinata	cm.18	gr.62	1
FTC20	Forbici Tolett. Curva Phoenix Cozyline	cm.20	gr.88	1
FTEC19	Forbici Toilettatura Curva Ehaso	cm.19	gr.72	1



<<  
LAC0672



>>  
LAC0681



<<  
LAC04089



<<  
BFS



<<  
LAC04090

Articolo	Descrizione	qmv
LAC0672	Laccetto Acciaio cm.58 Ø 5mm	1
LAC0681	Laccetto Large cm.87 Ø 5mm	1
LAC04089	Laccetto PVC cm.55 Ø 3mm	1
LAC04090	Laccetto nylon cm.43 Ø 8mm	1
BFS	Braccio flessibile x soffiatori	1



<<  
TU54001



<<  
TU34020 "S"  
TU34021 "L"



<<  
LIMA0655



>>  
LIMA



Articolo	Descrizione	qmv	crt
TU54001	Tagliaunghie a Forbice per gatti	3	12
TU34020	Tagliaunghie Pinza "S" cm.13x4,5 m/gomma	1	12
TU34021	" " "L" cm.16x5 m/gomma	1	12
LIMA0655	Lima manuale x Cane/Gatto	1	1
LIMA	Lima Moser x Unghie Cordless	1	1



<<  
CAM1221 "M"  
CAM1222 "L"



<<  
PSA50962 azzurro  
PSA50963 viola  
PSA50964 rosa



<<  
GREM



Articolo	Descrizione	qmv
CAM1221	Camice Letizia Nero/Arancio c/2 tasche "M"	1
CAM1222	" " " " "L"	1
GREM	Grembiule Giallo x Toilettatura	1
PSA50962	Panno Super Assorbente cm.66x43 Azzurro	1
PSA50963	" " " " cm.66x43 Viola	1
PSA50964	" " " " cm.66x43 Rosa	1



<<  
PTT0647



<<  
PAL19



<<  
PAL25



>>  
PTT32028

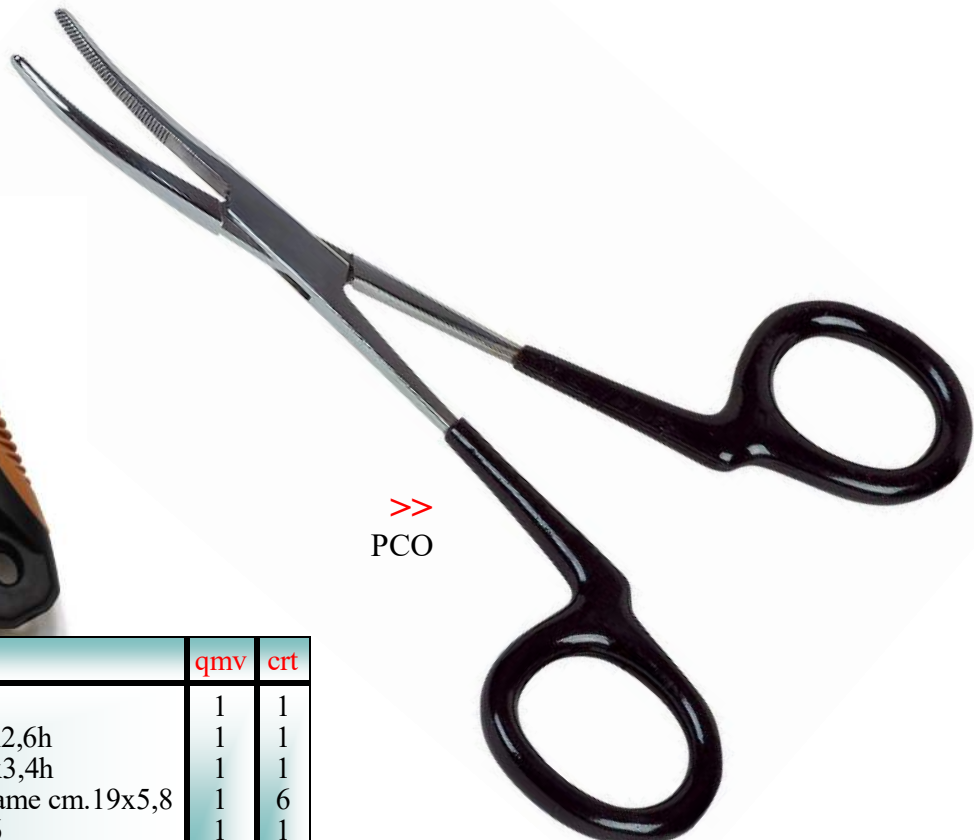

>>  
PCO

Articolo	Descrizione	qmv	crt
PTT0647	Pettine Pulci m/Plastica cm.16	1	1
PAL19	Pettine Acciaio Lungo cm.19x2,6h	1	1
PAL25	“ “ “ cm.25x3,4h	1	1
PTT32028	Taglianodi Semplice inox 9 Lame cm.19x5,8	1	6
PCO	Pinza Curva x Orecchie cm.16	1	1



<<  
CRD0751 denti soft

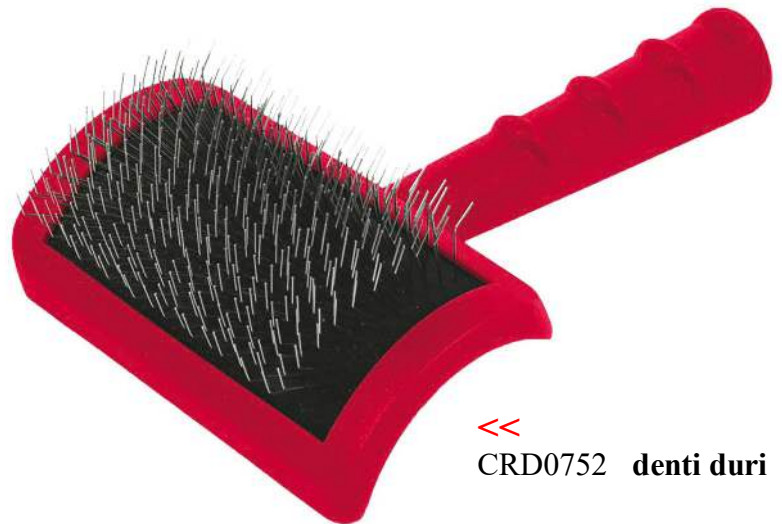

<<  
CRD0752 denti duri



<<  
CRD0149 denti rigidi

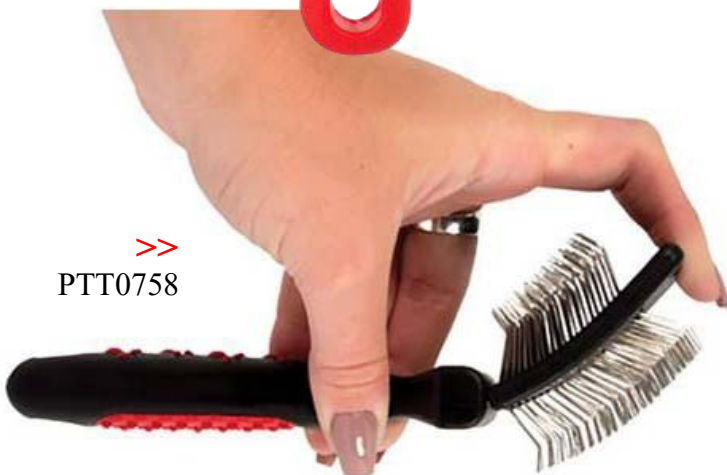

>>  
PTT0758



>>  
PTT0759

Articolo	Descrizione	qmv	crt
CRD0751	Card. Profess. Juliann cm.10x6x17 denti soft h.2,2	1	1
CRD0752	“ “ “ “ denti duri h.2,2	1	1
CRD0149	Card. Franck Universal cm.10x6x16 denti rigidi h.2,6	1	1
PTT0758	Cardatore Biflex cm.5,5	1	1
PTT0759	“ “ cm.7	1	1





<<  
8.DESH1



>>  
8.DESH2



<<  
8.DESH3

Articolo	Descrizione	qmv	crt
8.DESH1	8in1 Deshedder Small mm.47	1	6
8.DESH2	“ “ Medio mm.67	1	6
8.DESH3	“ “ Large mm.87	1	6



<<  
PTT32030



<<  
PRPC23854



<<  
PTT0354

cm. 4,5  
10 lame

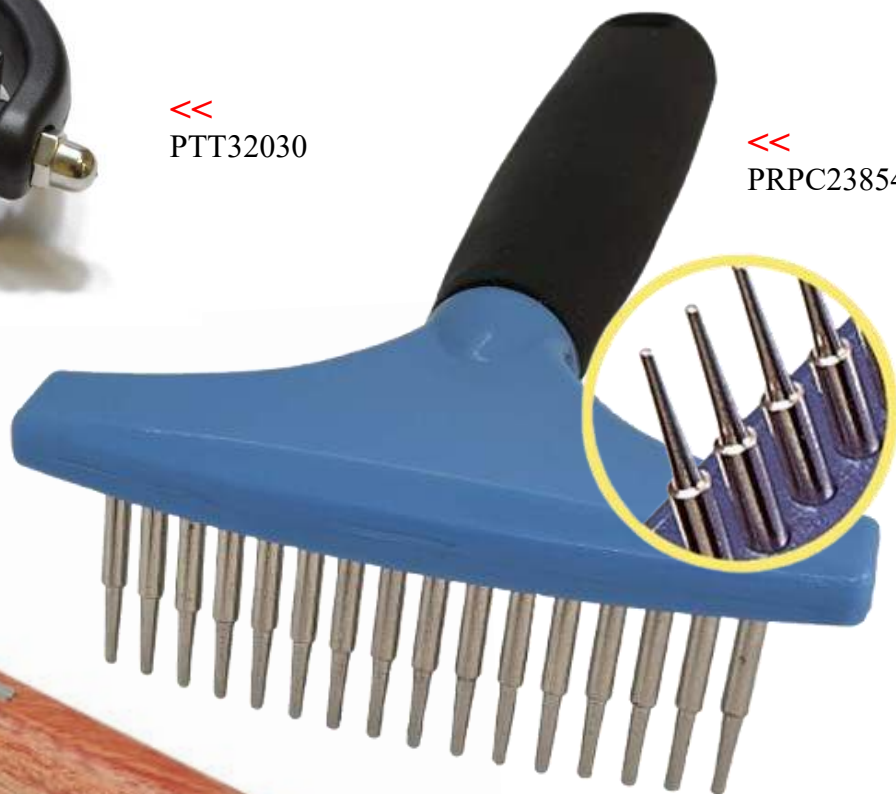

20 lame  
cm. 4,5  
ideale per la testa

<<  
PTT0351

Articolo	Descrizione	qmv	crt
PTT32030	Rastrello Taglianodi inox doppio 9+17 lame curve cm.7	1	6
PRPC23854	Rastrello Punta Coniche 16 Denti cm.9x14	2	20
PTT0354	Slanatore Inox m/legno 10 Lame cm.4,5	1	1
PTT0351	“ “ “ 20 Lame cm.4,5 ideale x la testa	1	1



**2.200 W**  
**2 velocità**  
**air speed: 59 lt/sec**  
**temperatura max 60°**  
**75 db**  
**collocabile a parete**



<< HARM



>> HARMRTN



<< HARMRF



>> HARMRFS



<< ZON

**2.400 W**  
**bimotore**  
**air speed: 128 lt/sec**  
**temperatura max 75°**  
**80 db**  
**tubo da mt.2**



>>  
ZEPHC

**1.200-2.200 W**  
**velocità regolabile**  
**air speed: 55 lt/sec**  
**temperatura max 52°**  
**77 db**  
**pede regolabile da 90 a 130cm**



>>  
ZONRM  
Motore Ricambio Universale



<<  
ZEPHRT  
Tubo x ZEPH mt.1,1  
HARMRT  
Tubo x HARM / ZON mt.1,1

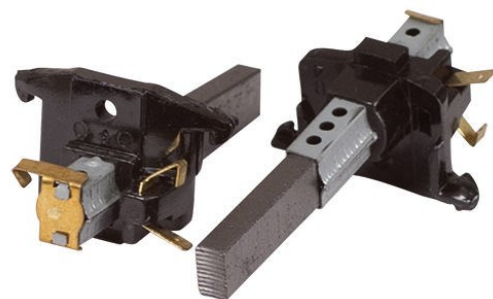

>>  
ZEPHRC  
Carboncini (set 2pz) universali



<<  
MIS+B

**motore Brushless  
con tecnologia Ionic  
(riduce effetto elettrostatico)  
1.800 W - 70-90db  
velocità regolabile  
air speed max: 40 lt/sec  
Temp. Regol. 25° - 75°  
braccio articolato fino 155cm  
piede regolabile da 110 a 138cm**



>>  
MIS+P



Articolo	Descrizione	qmv
MIS+B	Phon Brushless Mistral c/braccio	1
MIS+P	Phon Brushless Mistral c/piede+ ruote	1

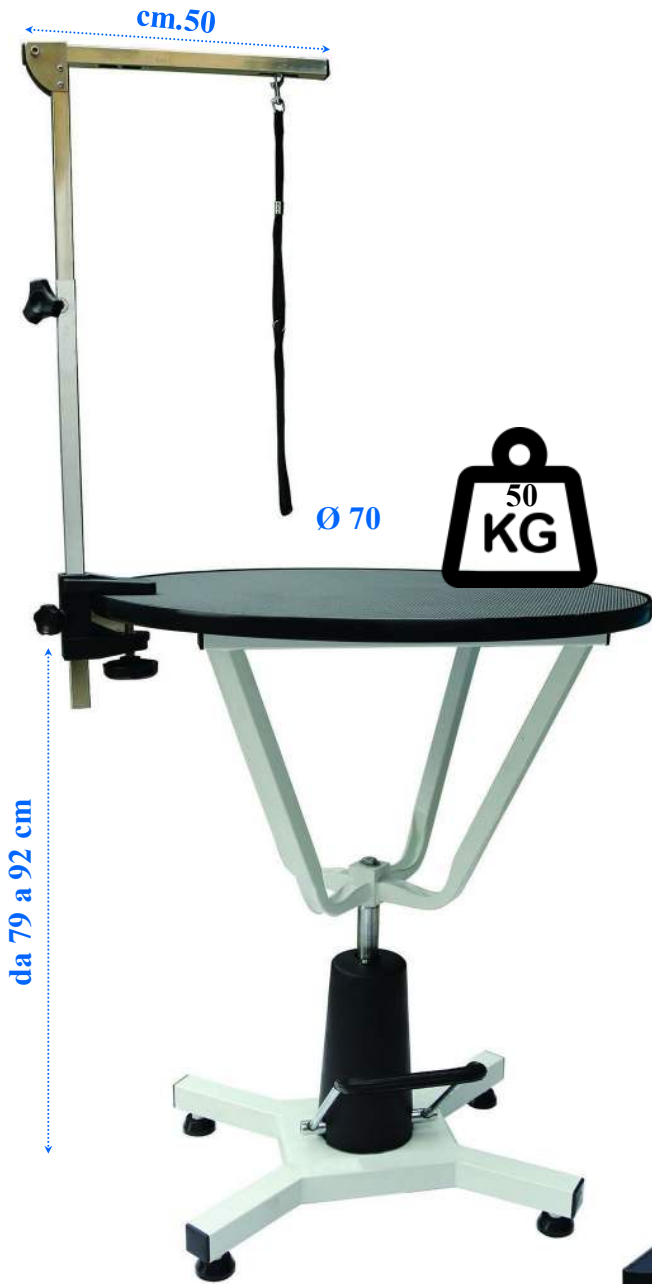

<<  
TAV0814

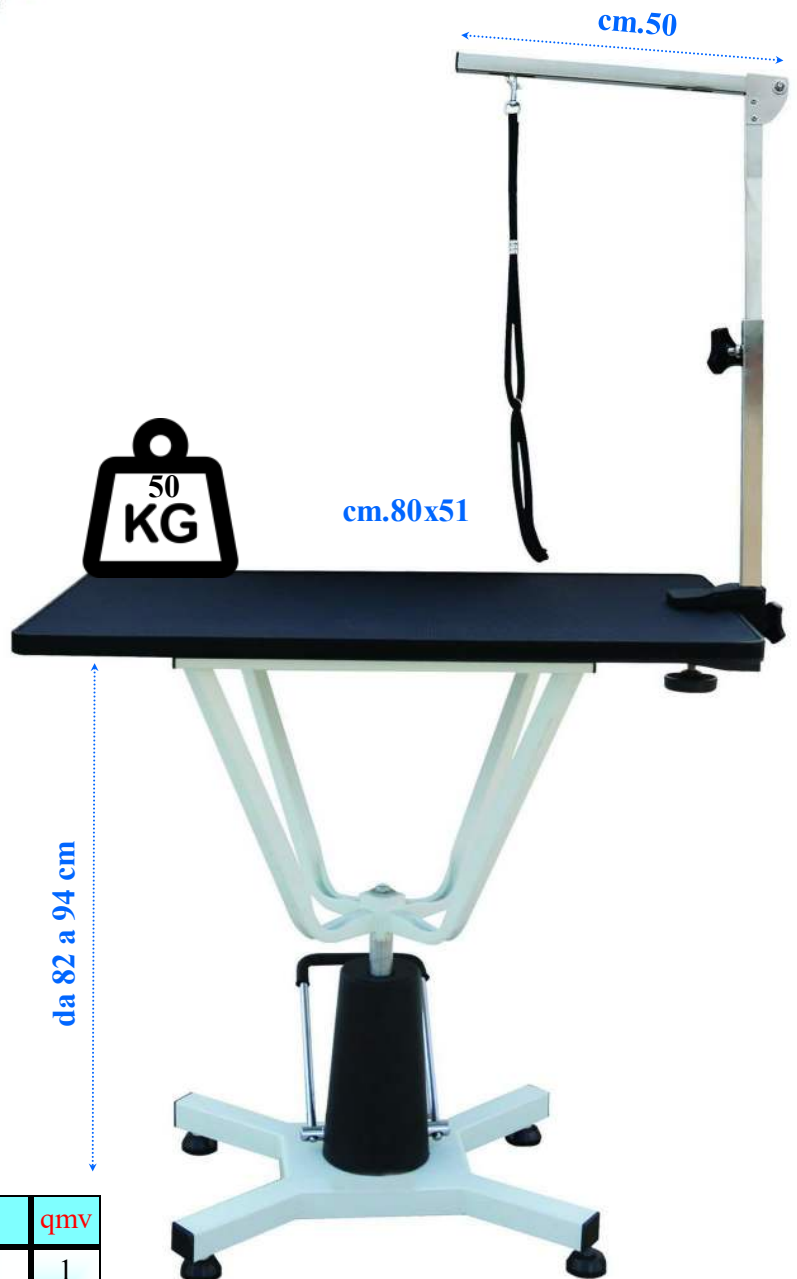

>>  
TAV0813

Articolo	Descrizione	qmv
TAV0814	Tavolo Rotante "Canis" Ø70 x 79-92h	1
TAV0813	" " "Sirius" cm.80x51x82-94h	1



<<  
TAV0822

>>  
TAV0877



Articolo	Descrizione	qmy
TAV0822	Tavolo Elettrico "Venere" cm.110x60x53-93h	1
TAV0877	" " "Callisto" cm.125x65x21-95h	1

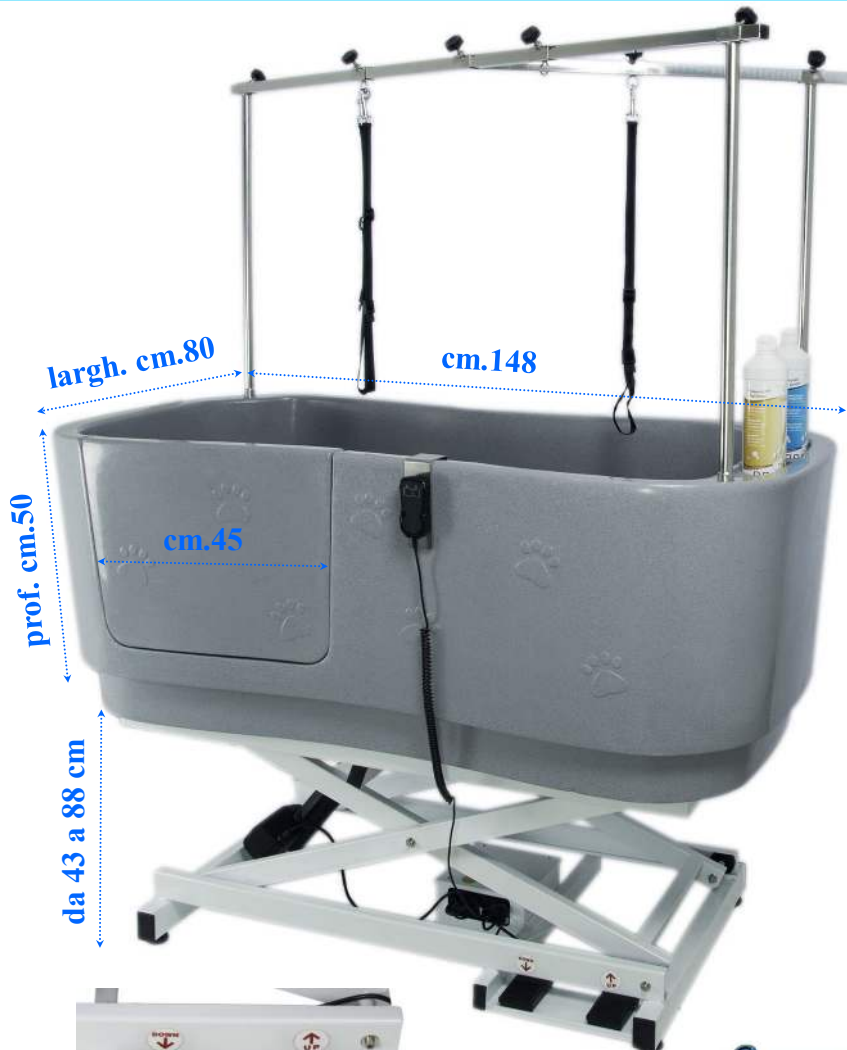

<< VAS1872

>> VAS1873



>> VAS1881

<< VAS1880



da 90 a 96 cm







**fornito di:  
piletta in acciaio inox  
miscelatore  
doccetta e portashampoo  
gru a bandiera c/2 anelli**

<<  
VAS1836



La scala in lamiera nervata è antiscivolo per garantire la sicurezza dell'animale. Si ritrae sotto la vasca da bagno per risparmiare spazio

il fondo di questa vasca è antiscivolo ed è regolabile in altezza per adattarsi a cani di piccola e grande taglia



<<  
VAS1838 c/porta DX  
VAS1839 c/porta SX

100 cm

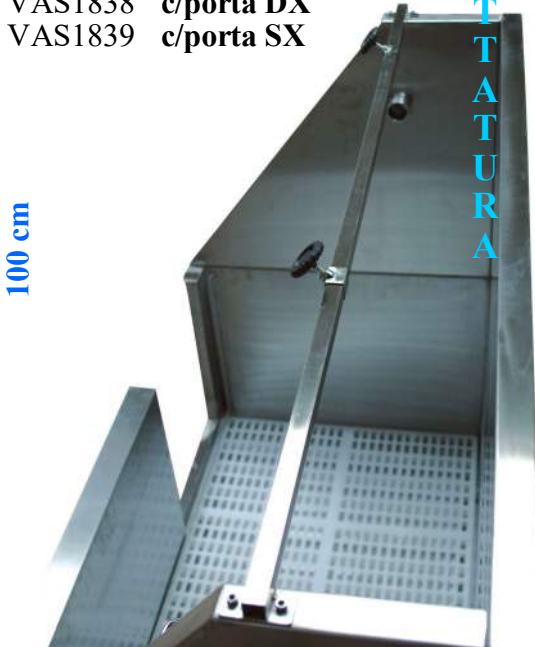

fornito di:  
miscelatore  
doccetta e portashampoo  
stelo c/2 anelli scorrev.





<<  
VAS1900

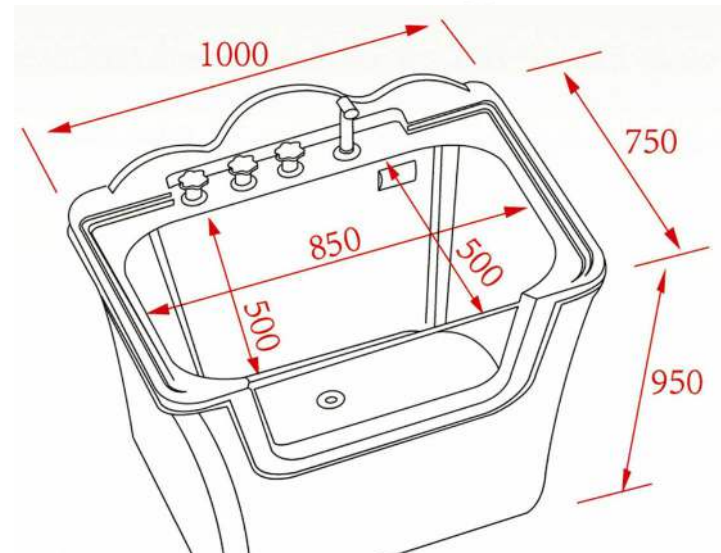

- Questa vasca da bagno è dotata di due funzioni SPA: una funzione di massaggio intenso e una delicata funzione di massaggio a bolle d'aria con luci a LED accese, offrendo agli animali domestici un'esperienza di lusso nella vasca SPA.
  - Le funzioni possono essere selezionate facilmente tramite un pannello di controllo.
  - Questa vasca da bagno PET SPA è realizzata in plastica ABS, rinforzata con fibra di vetro, resistente e durevole per uso interno, adatta per animali domestici di medie e piccole dimensioni.
  - L'altezza della vasca è perfetta per i toilettatori in quanto possono prendersi cura dell'animale in piedi. Non c'è bisogno di chinarsi.
  - La vasca da bagno ha una superficie inferiore piatta e goffrata che consente all'animale di stare in piedi o sedersi nella vasca da bagno in sicurezza.
  - Sono disponibili due percorsi di ingresso dell'acqua: attraverso un rubinetto o un soffione. Una griglia di raccolta delle setole impedisce alle setole di scendere nello scarico.
- per animali domestici **fino a 100 kg** capacità di **litri 190**



TFP08753 cm. 87x58x67h  
 TFP08754 cm.107x68x75h  
 TFP08755 cm.118x78x85h



BPC1 cm.60x42x51h  
 BPC2 cm.77x46x55h  
 BPC3 cm.97x57x66h



Articolo	Descrizione	qmv
TFP08753	Trasp. Ferro Piegh. 2 porte cm. 87x58x67h	1
TFP08754	“ “ “ 2 porte cm.107x68x75h	1
TFP08755	“ “ “ 2 porte cm.118x78x85h	1
BPC1	Box Pieghevole x cani 1P cm.60x42x51h	1
BPC2	“ “ “ 1P cm.77x46x55h	1
BPC3	“ “ “ 2P cm.97x57x66h	1



<<  
SHA10T



<<  
SHA10F



<<  
SHA10A



>>  
SHA10AC

Articolo	Descrizione	qmv	crt
SHA10T	Shampoo Enjoy Talco Tanica da lt.10	1	1
SHA10F	“ “ Fruit Tanica da lt.10	1	1
SHA10A	“ “ Avena Ipoall.Amm.Conc.lt.10	1	1
SHA10AC	“ “ Aloe & Cocco pelo lungo lt.10	1	1



<< SHAP10 kg.10



>> IGN24976



<< CA.ZSH2L



## Balsamo

<< IGN24973

Articolo	Descrizione	qmv	crt
SHAP10	Shampoo Professionale in Pasta da kg. 10	1	1
IGN24976	Shampoo Pet Style Manti Bianchi lt.5	1	4
CA.ZSH2L	Shampoo Antiparassitario Zanco lt.2	1	3
IGN24973	Balsamo Pet Style tanica lt.5	1	4



<<  
IGN0054



>>  
IGN8310

>>  
IGN0055



>>  
IGN8125



Profumo

Lucidante



<<  
PV.DSA



<<  
PV.DSM



>>  
PV.DSL

>>  
PV.DST

Articolo	Descrizione	qmv	crt
IGN0054	Profumo Alcohol Free Coco - Vanilla ml.500	1	1
IGN0055	“ “ “ Little Sugar ml.500	1	1
IGN8125	Spray Lucidante Olio Visone ml.300	1	12
IGN8310	Profumo Dog Generation spray ml.500	1	12
PV.DSA	Deo Spray Inodorina ml.300 Aloe	1	6
PV.DSL	“ “ “ ml.300 Latte Vaniglia	1	6
PV.DSM	“ “ “ ml.300 Muschio Bianco	1	6
PV.DST	“ “ “ ml.300 Talco	1	6



<< CLOSH250



<< CLOSH4/250

>> CLOSO200



<< CLOSG100

*idratante  
disinfettante*

<< CLOSS200



>> CLOSO4/200

Articolo	Descrizione	qmv	crt
CLOSH250	Clorexyderm Shampoo	ml.250	1 6
CLOSH4/250	“ Shampoo 4%	ml.250	1 6
CLOSG100	Clorexyderm Spot Gel	ml.100	1 6
CLOSS200	Clorexyderm sol. Schiuma	ml.200	1 6
CLOSO200	Clorexyderm Soluzione	ml.200	1 6
CLOSO4/200	“ Soluzione 4%	ml.200	1 6





<< CLOOTO150

detergente auricolare



<< CLOOTO100

x otiti batteriche



>> CLOOTOA

ceruminolitico



<< CLOLENSH

idrosilato di avena  
cute sensibile o irritata



<< CLOLENSP

latte di avena



>> CLOZS

x forfora e prurito

Articolo	Descrizione	qmv	crt
CLOOTO150	Clorexyderm Oto ml.150	1	6
CLOOTO100	Otodine ml.100	1	6
CLOOTOA	Otoact ml.100 ceruminolitico	1	6
CLOLENSH	Leniderm Shampoo ml.250	1	6
CLOLENSP	“ Spuma ml.200	1	6
CLOZS	Zincoseb Shampoo ml.250	1	6

2025



Ringrazia

per  
la



preferenza

